

# Product data sheet

Specifications



## logic controller, Modicon M221, 24 IO, transistor, PNP, Ethernet

TM221CE24T

### Main

Range of Product	Modicon M221
Product or Component Type	Logic controller
[Us] rated supply voltage	24 V DC
Discrete input number	14, discrete input 4 fast input IEC 61131-2 Type 1
Analogue input number	2 0...10 V
Discrete output type	Transistor
Discrete output number	10 transistor 2 fast output
Discrete output voltage	24 V DC
Discrete output current	0.5 A

### Complementary

Discrete I/O number	24
Maximum number of I/O expansion module	7 (local I/O-Architecture) 14 (remote I/O-Architecture)
Supply voltage limits	20.4...28.8 V
Inrush current	35 A
Maximum power consumption in W	14 W 24 V with max number of I/O expansion module) 4.8 W 24 V without I/O expansion module)
Power supply output current	0.52 A 5 V expansion bus 0.2 A 24 V expansion bus
Discrete input logic	Sink or source (positive/negative)
Discrete input voltage	24 V
Discrete input voltage type	DC
Analogue input resolution	10 bits
LSB value	10 mV
Conversion time	1 ms per channel + 1 controller cycle time analog input
Permitted overload on inputs	+/- 30 V DC 5 min maximum)analog input +/- 13 V DC permanent)analog input
Voltage state 1 guaranteed	$\geq 15$ V input
Voltage state 0 guaranteed	$\leq 5$ V input

<b>Discrete input current</b>	7 mA discrete input 5 mA fast input
<b>Input impedance</b>	3.4 kOhm discrete input 100 kOhm analog input 4.9 kOhm fast input
<b>Response time</b>	35 µs turn-off, I2...I5 input 5 µs turn-on, I0, I1, I6, I7 fast input 35 µs turn-on, other terminals input 5 µs turn-off, I0, I1, I6, I7 fast input 100 µs turn-off, other terminals input 5 µs turn-on, turn-off, Q0...Q1 output 50 µs turn-on, turn-off, Q2...Q3 output 300 µs turn-on, turn-off, other terminals output
<b>Configurable filtering time</b>	0 ms input 3 ms input 12 ms input
<b>Discrete output logic</b>	Positive logic (source)
<b>Maximum current per output common</b>	5 A
<b>Output Frequency (sync to mains)</b>	100 kHz fast output (PWM/PLS mode) Q0...Q1 5 kHz output Q2...Q3 0.1 kHz output Q4...Q9
<b>Absolute accuracy error</b>	+/- 1 % of full scale analog input
<b>Maximum leakage current</b>	0.1 mA transistor output
<b>Maximum voltage drop</b>	<1 V
<b>Mechanical durability</b>	20000000 cycles transistor output
<b>Maximum tungsten load</b>	<12 W output and fast output
<b>Protection type</b>	Overload and short-circuit protection 1 A
<b>Reset time</b>	1 s automatic reset
<b>Memory capacity</b>	256 kB user application and data RAM 10000 instructions 256 kB internal variables RAM
<b>Data backed up</b>	256 kB built-in flash memory backup of application and data
<b>Data storage equipment</b>	2 GB SD card optional)
<b>Battery type</b>	BR2032 or CR2032X lithium non-rechargeable
<b>Backup time</b>	1 year 77 °F (25 °C) by interruption of power supply)
<b>Execution time for 1 KInstruction</b>	0.3 ms event and periodic task
<b>Execution time per instruction</b>	0.2 µs Boolean
<b>Exct time for event task</b>	60 µs response time
<b>Maximum size of object areas</b>	255 %C counters 512 %M memory bits 8000 %MW memory words 512 %KW constant words 255 %TM timers
<b>Realtime clock</b>	With
<b>Clock drift</b>	<= 30 s/month 77 °F (25 °C)
<b>Regulation loop</b>	Adjustable PID regulator up to 14 simultaneous loops
<b>Positioning functions</b>	PTO 2 pulse/direction 100 kHz) PTO 1 CW/CCW 100 kHz)
<b>Function Available</b>	Frequency generator PLS PWM
<b>Counting input number</b>	4 fast input (HSC mode) 100 kHz 32 bits
<b>Counter function</b>	A/B Single phase Pulse/direction
<b>Integrated connection type</b>	USB port mini B USB 2.0 Non isolated serial link serial 1 RJ45 RS232/RS485

	Ethernet RJ45
<b>Supply</b>	Serial)serial link supply 5 V, <200 mA
<b>Transmission rate</b>	1.2...115.2 kbit/s (115.2 kbit/s by default) 49.21 ft (15 m) RS485 1.2...115.2 kbit/s (115.2 kbit/s by default) 9.84 ft (3 m) RS232 480 Mbit/s USB
<b>Communication port protocol</b>	USB port USB - SoMachine-Network Non isolated serial link Modbus master/slave - RTU/ASCII or SoMachine-Network Ethernet
<b>Port Ethernet</b>	10BASE-T/100BASE-TX 1 328.08 ft (100 m) copper cable
<b>Communication Service</b>	Modbus TCP slave device Modbus TCP server Modbus TCP client Ethernet/IP adapter DHCP client
<b>Local signalling</b>	for PWR 1 LED (green) for RUN 1 LED (green) for module error (ERR) 1 LED (red) for SD card access (SD) 1 LED (green) for BAT 1 LED (red) for I/O state 1 LED per channel (green) for SL 1 LED (green) for ACT Ethernet network activity (green) for Link (Link Status) Ethernet network link (yellow)
<b>Electrical connection</b>	removable screw terminal block for inputs removable screw terminal block for outputs terminal block, 3 for connecting the 24 V DC power supply connector, 4 for analogue inputs Mini B USB 2.0 connector for a programming terminal
<b>Maximum cable distance between devices</b>	Shielded cable <32.81 ft (10 m) fast input Unshielded cable <98.43 ft (30 m) output Unshielded cable <98.43 ft (30 m) digital input Unshielded cable <3.28 ft (1 m) analog input Shielded cable <9.84 ft (3 m) fast output
<b>Insulation</b>	Between input and internal logic 500 V AC Between fast input and internal logic 500 V AC Non-insulated between inputs Between output and internal logic 500 V AC Non-insulated between analogue input and internal logic Non-insulated between analogue inputs
<b>Marking</b>	CE
<b>Mounting support</b>	Top hat type TH35-15 rail IEC 60715 Top hat type TH35-7.5 rail IEC 60715 plate or panel with fixing kit
<b>Height</b>	3.54 in (90 mm)
<b>Depth</b>	2.76 in (70 mm)
<b>Width</b>	4.33 in (110 mm)
<b>Net Weight</b>	0.87 lb(US) (0.395 kg)
<b>Environment</b>	
<b>Standards</b>	EN/IEC 61131-2 UL 508 CAN/CSA C22.2 No. 213 IACS E10 ANSI/ISA 12-12-01
<b>Product Certifications</b>	ABS EAC RCM cULus LR DNV-GL CE UKCA cULus HazLoc
<b>Environmental characteristic</b>	Ordinary and hazardous location
<b>Resistance to electrostatic discharge</b>	8 kV in air EN/IEC 61000-4-2 4 kV on contact EN/IEC 61000-4-2
<b>Resistance to electromagnetic fields</b>	9.14 V/m (10 V/m) 80 MHz...1 GHz EN/IEC 61000-4-3 2.74 V/m (3 V/m) 1.4 GHz...2 GHz EN/IEC 61000-4-3 0.91 V/m (1 V/m) 2...2.7 GHz EN/IEC 61000-4-3

<b>Resistance to magnetic fields</b>	98.43 A/m (30 A/m) 50/60 Hz EN/IEC 61000-4-8
<b>Resistance to fast transients</b>	2 kV EN/IEC 61000-4-4 power lines) 2 kV EN/IEC 61000-4-4 relay output) 1 kV EN/IEC 61000-4-4 I/O) 1 kV EN/IEC 61000-4-4 Ethernet line) 1 kV EN/IEC 61000-4-4 serial link)
<b>Surge withstand</b>	2 kV power lines (AC) common mode EN/IEC 61000-4-5 2 kV relay output common mode EN/IEC 61000-4-5 1 kV I/O common mode EN/IEC 61000-4-5 1 kV shielded cable common mode EN/IEC 61000-4-5 0.5 kV power lines (DC) differential mode EN/IEC 61000-4-5 1 kV power lines (AC) differential mode EN/IEC 61000-4-5 1 kV relay output differential mode EN/IEC 61000-4-5 0.5 kV power lines (DC) common mode EN/IEC 61000-4-5
<b>Resistance to conducted disturbances</b>	10 V 0.15...80 MHz EN/IEC 61000-4-6 3 V 0.1...80 MHz Marine specification (LR, ABS, DNV, GL) 10 V spot frequency (2, 3, 4, 6.2, 8.2, 12.6, 16.5, 18.8, 22, 25 MHz) Marine specification (LR, ABS, DNV, GL)
<b>Electromagnetic emission</b>	Conducted emissions 79 dB $\mu$ V/m QP/66 dB $\mu$ V/m AV power lines (AC))0.15...0.5 MHz EN/IEC 55011 Conducted emissions 73 dB $\mu$ V/m QP/60 dB $\mu$ V/m AV power lines (AC))0.5...300 MHz EN/IEC 55011 Conducted emissions 120...69 dB $\mu$ V/m QP power lines)10...150 kHz EN/IEC 55011 Conducted emissions 63 dB $\mu$ V/m QP power lines)1.5...30 MHz EN/IEC 55011 Radiated emissions 40 dB $\mu$ V/m QP class A 10 m)30...230 MHz EN/IEC 55011 Conducted emissions 79...63 dB $\mu$ V/m QP power lines)150...1500 kHz EN/IEC 55011 Radiated emissions 47 dB $\mu$ V/m QP class A 10 m)200...1000 MHz EN/IEC 55011
<b>Immunity to microbreaks</b>	10 ms
<b>Ambient air temperature for operation</b>	14...131 °F (-10...55 °C) horizontal installation) 14...95 °F (-10...35 °C) vertical installation)
<b>Ambient Air Temperature for Storage</b>	-13...158 °F (-25...70 °C)
<b>Relative humidity</b>	10...95 %, without condensation in operation) 10...95 %, without condensation in storage)
<b>IP degree of protection</b>	IP20 with protective cover in place
<b>Pollution degree</b>	<= 2
<b>Operating altitude</b>	0...6561.68 ft (0...2000 m)
<b>Storage altitude</b>	0.00...9842.52 ft (0...3000 m)
<b>Vibration resistance</b>	3.5 mm 5...8.4 Hz symmetrical rail 3.5 mm 5...8.4 Hz panel mounting 1 gn 8.4...150 Hz symmetrical rail 1 gn 8.4...150 Hz panel mounting
<b>Shock resistance</b>	147 m/s <sup>2</sup> 11 ms

## Ordering and shipping details

<b>Category</b>	22533-M2XX PLC & ACCESSORIES
<b>Discount Schedule</b>	MSX
<b>GTIN</b>	3606480648786
<b>Returnability</b>	Yes
<b>Country of origin</b>	TW

## Packing Units

<b>Unit Type of Package 1</b>	PCE
<b>Number of Units in Package 1</b>	1
<b>Package 1 Height</b>	4.38 in (11.133 cm)
<b>Package 1 Width</b>	5.57 in (14.136 cm)
<b>Package 1 Length</b>	6.14 in (15.607 cm)
<b>Package 1 Weight</b>	21.90 oz (621.0 g)
<b>Unit Type of Package 2</b>	CAR

<b>Number of Units in Package 2</b>	20
<b>Package 2 Height</b>	11.69 in (29.7 cm)
<b>Package 2 Width</b>	15.67 in (39.8 cm)
<b>Package 2 Length</b>	22.44 in (57.0 cm)
<b>Package 2 Weight</b>	29.13 lb(US) (13.211 kg)
<b>Unit Type of Package 3</b>	P12
<b>Number of Units in Package 3</b>	240
<b>Package 3 Height</b>	41.34 in (105.0 cm)
<b>Package 3 Width</b>	47.24 in (120.0 cm)
<b>Package 3 Length</b>	31.50 in (80.0 cm)
<b>Package 3 Weight</b>	207.23 lb(US) (94 kg)

## Offer Sustainability

<b>Sustainable offer status</b>	Green Premium product
<b>California proposition 65</b>	WARNING: This product can expose you to chemicals including: Lead and lead compounds, which is known to the State of California to cause cancer and birth defects or other reproductive harm. For more information go to <a href="http://www.P65Warnings.ca.gov">www.P65Warnings.ca.gov</a>
<b>REACH Regulation</b>	<a href="#">REACH Declaration</a>
<b>EU RoHS Directive</b>	Pro-active compliance (Product out of EU RoHS legal scope) <a href="#">EU RoHS Declaration</a>
<b>Mercury free</b>	Yes
<b>China RoHS Regulation</b>	<a href="#">China RoHS declaration</a>
<b>RoHS exemption information</b>	Yes
<b>Environmental Disclosure</b>	<a href="#">Product Environmental Profile</a>
<b>Circularity Profile</b>	<a href="#">End of Life Information</a>
<b>WEEE</b>	The product must be disposed on European Union markets following specific waste collection and never end up in rubbish bins.
<b>PVC free</b>	Yes

Dimensions

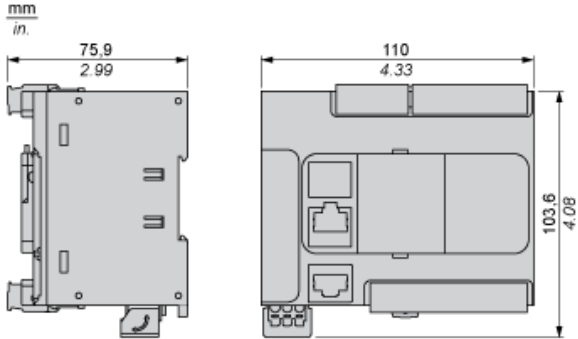

**Mounting on a Rail**

---

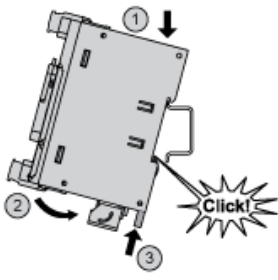

**Direct Mounting on a Panel Surface**

---

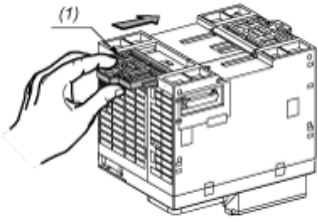

(1) Install a mounting strip

**Mounting Hole Layout**

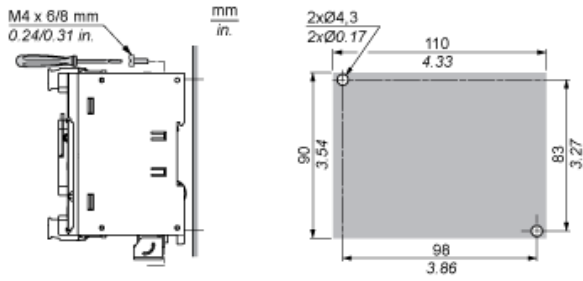

**Mounting**

---

**Correct Mounting Position**

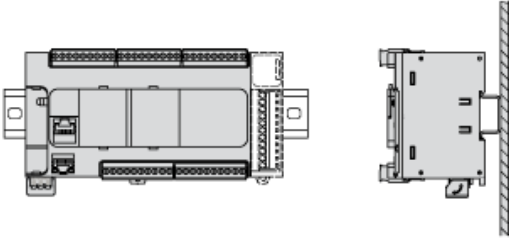

**Acceptable Mounting Position**

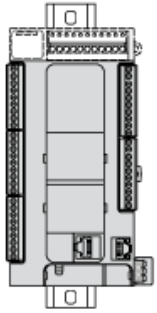

**Incorrect Mounting Position**

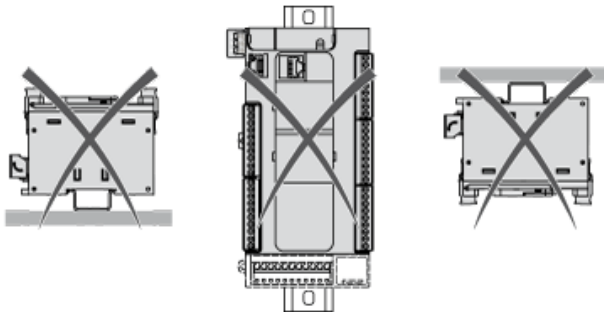

Clearance

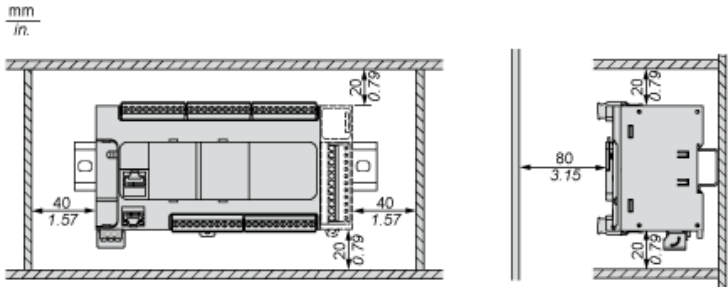

## Digital Inputs

---

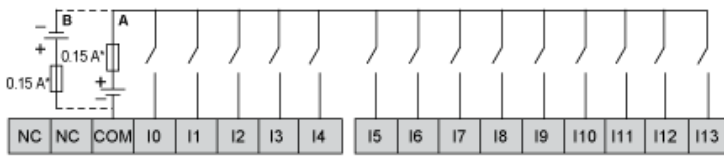

- (\*) Type T fuse
- (A) Sink wiring (positive logic).
- (B) Source wiring (negative logic).

## Connection of the Fast Inputs

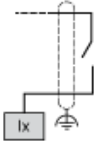

I0, I1, I6, I7

Transistor Outputs

---

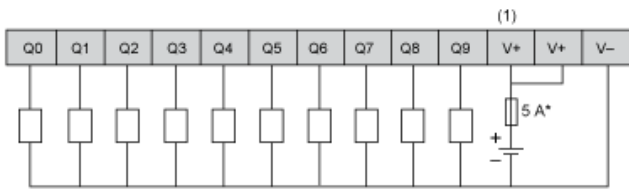

- (\*) Type T fuse
- (1) The V+ terminals are connected internally.

Connection of the Fast Outputs

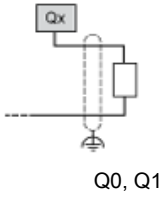

**Analog Inputs**

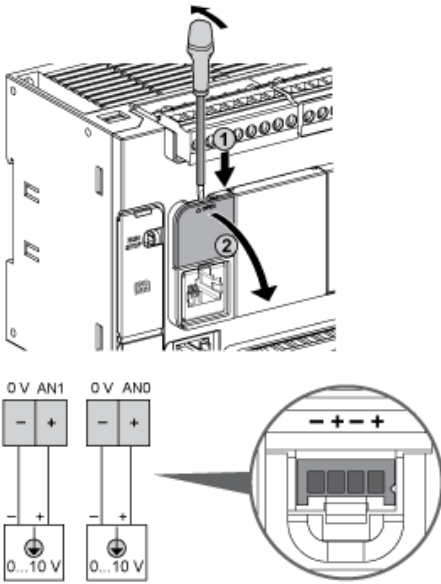

The (-) poles are connected internally.

Pin	Wire Color
0 V	Black
AN1	Red
0 V	Black
AN0	Red

## Ethernet Connection

---

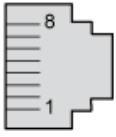

Pin N°	Signal
1	TD+
2	TD-
3	RD+
4	-
5	-
6	RD-
7	-
8	-

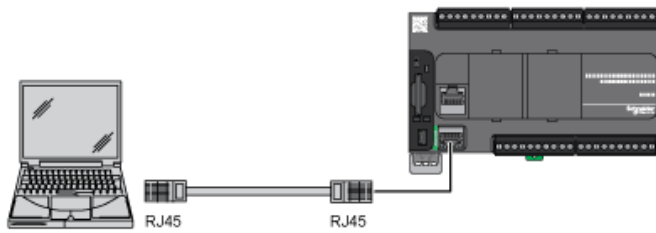

## USB Mini-B Connection

---

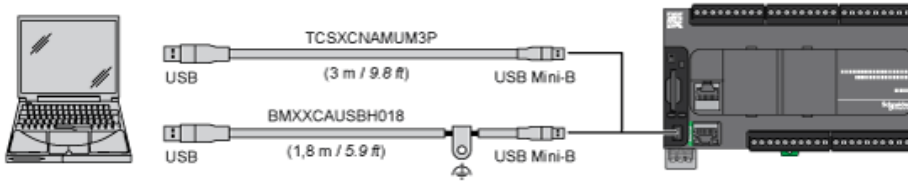

**SL1 Connection**

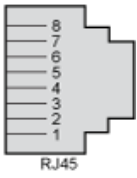

SL1

N °	RS 232	RS 485
1	RxD	N.C.
2	TxD	N.C.
3	RTS	N.C.
4	N.C.	D1
5	N.C.	D0
6	CTS	N.C.
7	N.C.*	5 Vdc
8	Common	Common

N.C.: not connected

\* : 5 Vdc delivered by the controller. Do not connect.

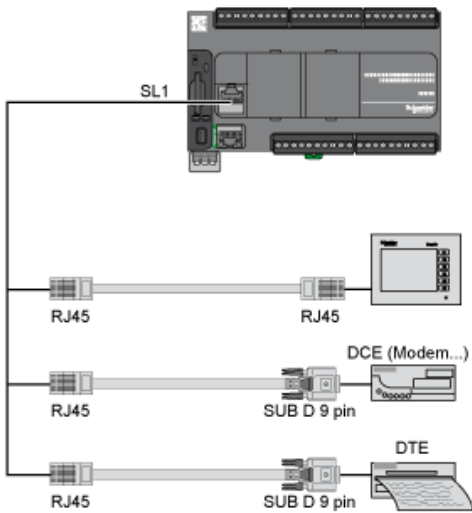

Derating Curves

Embedded Digital Inputs (No Cartridge)

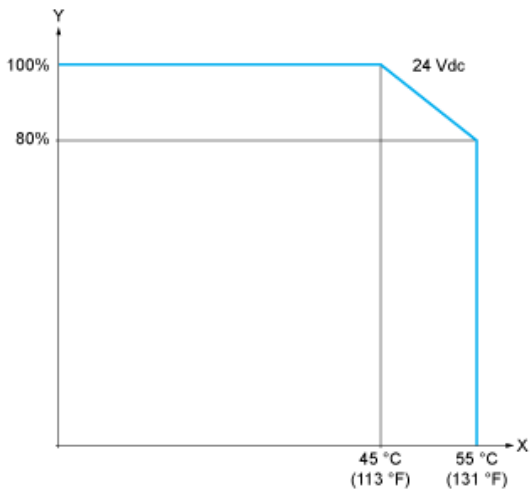

X : Ambient temperature  
Y : Input simultaneous ON ratio

Embedded Digital Inputs (with Cartridge)

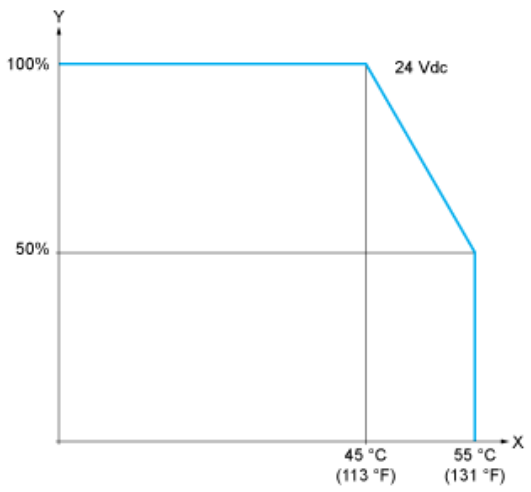

X : Ambient temperature  
Y : Input simultaneous ON ratio

**Derating Curves**

---

**Embedded Digital Outputs (No Cartridge)**

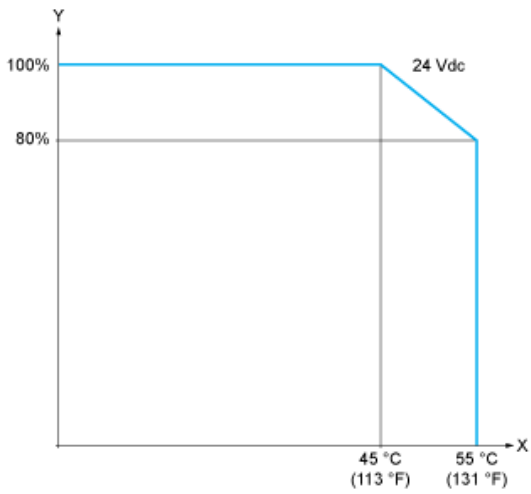

X : Ambient temperature  
Y : Output simultaneous ON ratio

**Embedded Digital Outputs (with Cartridge)**

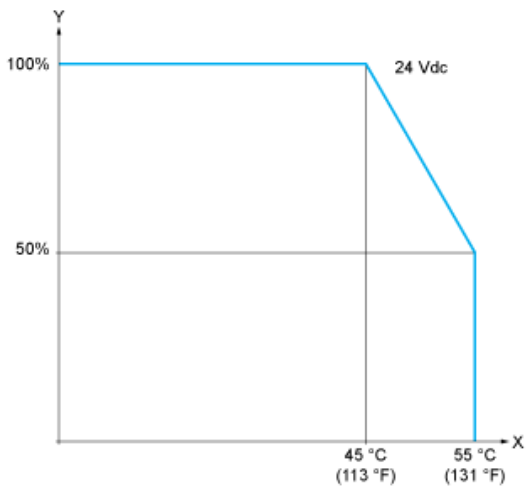

X : Ambient temperature  
Y : Output simultaneous ON ratio

**Recommended replacement(s)**